

Level Delta



Company:

Street + number:

Postal code + town:

Country :

Tel: +.. /

Email:

VAT:

Order Reference:

Recipient name:

Street + number:

Postal code + town:

Country:

Telephone number for delivery:

Accessible with lorry? YES NO

Is a forklift needed? YES NO
mandatory if delivery to end customer

Pick up organized by customer

Requested delivery date:

Reference client (for delivery):

Pool information

SHAPE (add a drawing)

Rectangular Special shape

STAIR SECTION

Roman Trapezium Rectangular

TYPE OF POOL

Liner pool NO YES (welded on site / one piece pre-fabricated liner) One piece pool* (reference:)
Inox Stepoc/Styropor Mosaic/Ceramic Polypropylene

* It is not recommended to use this drive system for this type of pool

Skimmer pool

Overflow pool

Both long sides

Mirror pool

One long side (add this to the plan)

Side opposite to the system

Other (please add drawing)

Specify the pool width including the overflow stones cm

It is not possible to install this system on overflow copings. The cover pit walls must be above water level.

TYPE OF WATER TREATMENT

Chlorine

Salt electrolysis

Other :

SYSTEM CONFIGURATION:

Wall conduit

Own wall conduit

Wall conduit is already installed

Cable protection

Please add measurements to be as clear as possible (in cm). Include your own plan as well.

**Rectangular
Special shape**

(except polycarbonate and flat slats)

LEVEL DELTA

90 degree corners

Rounded corners: cm

Bevelled corners: A: cm B: cm C: cm

90 degree corners

Rounded corners: cm

Bevelled corners: A: cm B: cm C: cm

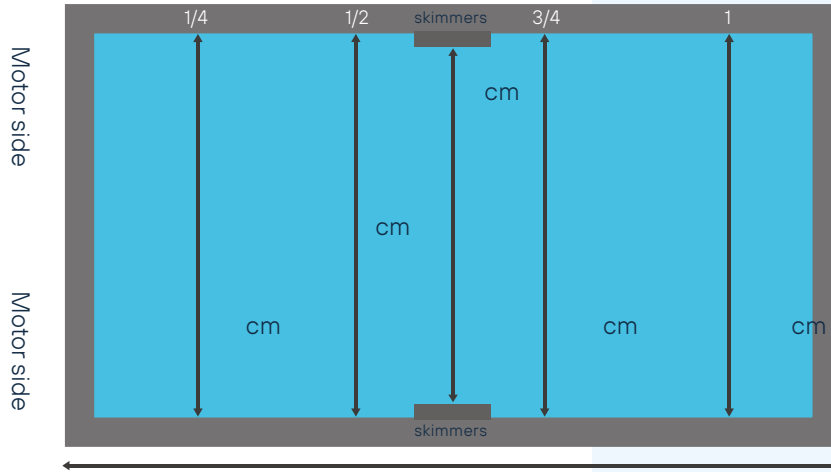

BEVELLED CORNERS

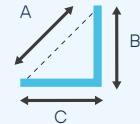

90 degree corners

Rounded corners: cm

Bevelled corners: A: cm B: cm C: cm

90 degree corners

Rounded corners: cm

Bevelled corners: A: cm B: cm C: cm

Stairs Cutout



Rectangular



Special shape (except polycarbonate and flat slats)

STRAIGHT STAIR SECTION

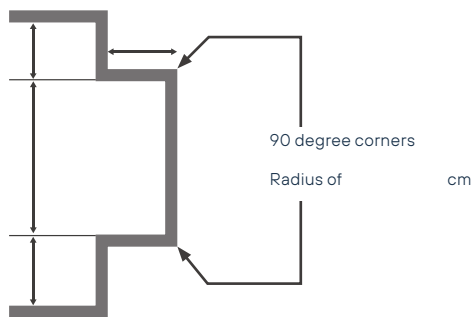

TRAPEZIUM STAIR SECTION

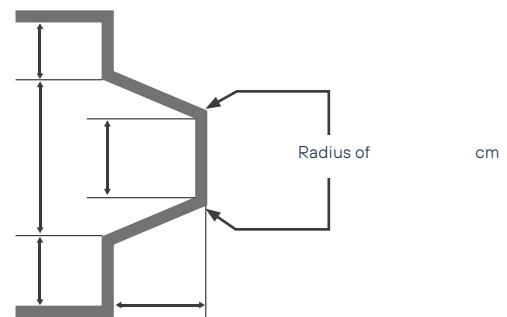

ROMAN STAIR SECTION

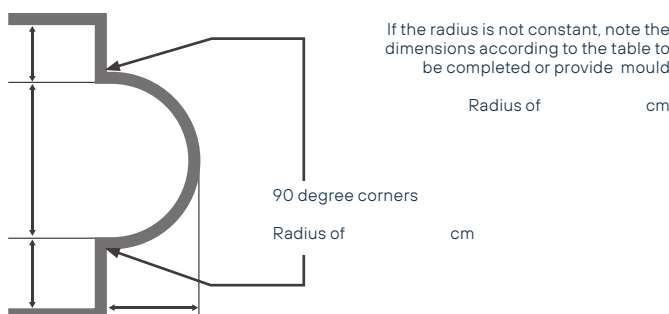

Divide the half circle of the staircase into 8 equal parts. Read the dimensions of : (e.g. from 1 to 4; from 4 to 9..)

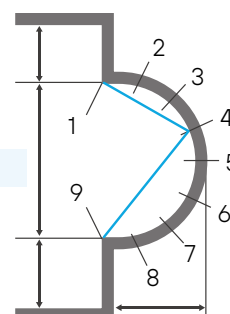

1/2	cm
2/9	cm
1/3	cm
3/9	cm
1/4	cm
4/9	cm
1/5	cm
5/9	cm
1/6	cm
6/9	cm
1/7	cm
7/9	cm
1/8	cm
8/9	cm
1/8	cm

COVER PIT DIMENSIONS:

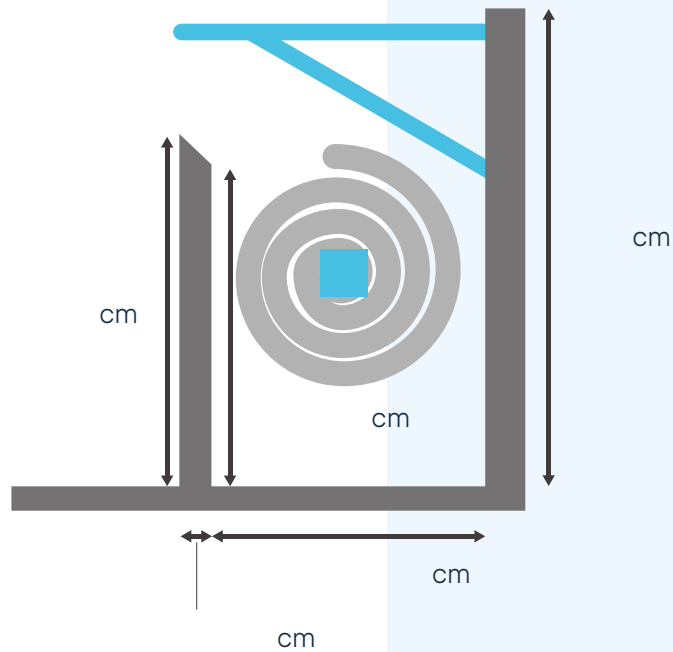

Slats

CLASSIC

Cream White (RAL9001)

Arctic Blue (RAL5012)

Silex Grey (RAL 7032)

Pebble Grey (RAL7004)

Steel Grey (RAL7037)

SOLAR

Alu

Blue

Midnight

PEARL

Pearl

Control panels



CoverControl (standard)



PC Mini
PC Go

PC Mini AP

Other control panel Covrex:

Options



Remote control (not available in France):
2-channels remote control
4-channels remote control



Grounding set
(obligatory with salt electrolysis)



Antenne for remote control
with 10 meter cable



Extra motor cable (above 5m cable supplied
with the motor) cm



Safety lock wall fixation



Angled bracket for safety lock
coping stone fixation



Guiding wheels for overflow pools (set of 2)



Liner protection caps (for Covrex Classic):
installed loose



Handrail in stainless steel (per m) m
fixation in the wall
fixation under coping stones

Comments

Signature & stamp

(OBLIGATORY)

order date: